

Specifications

Type	95cc	
Part number	14571345	
Displacement	95	cc/rev
Port configuration	2 side / 2 rear	
Shaft DIN 5462	8*32*36	mm
Inlet - straight internal thread	1 ¼"	BSP
Outlet - straight internal thread	1 ¼"	BSP
Minimum suction hose diameter	1 ¼"	inch
Torque at 250bar	390	Nm
p2 : Max. pressure for tipping application	250	bar
p3 : Max. continuous pressure	230	bar
p1 : Max. peak pressure	255	bar
L : Length of pump	192	mm
W : Width before ports	134	mm
W1 : Width of pump	148	mm
H : Height pump	148.5	mm
A : Position side port	116	mm
B : Position rear port	34	mm
Mass	15.5	kg
Centre of gravity distance (COG)	96	mm

Type	95cc	
Max. Torque	500	Nm
Flow at 2500 rpm	237	l/min
Max. speed at intermittent pressure*	2500	rpm
Min. speed at intermittent pressure	300	rpm
Oil temperature range	min / max -40 / 80	°C
Inlet pressure range (suction side)	min / max 0.7 / 3	bar
Recommended oil viscosity range	min / max 12 / 100	mm ² /s
Max. starting viscosity*	1500	mm ² /s
Min. filtration	25	µm
Noise level at 1000 rpm and 100 bar	65	dB
Leak indicator included with the pump	Yes	
Gasket included with the pump	Yes	

* 2500 rpm for oil viscosity up to 100 cSt. 1000 rpm for cold start (1500 cSt).

Technical notes

- Recommended oil is mineral based; for other fluids contact our engineering department
- Mentioned filtration is for tipper applications only
- To avoid cavitation, suction hose must be kept as short and straight as possible and oil viscosity should be respected at all operating temperatures
- Painted black (RAL9005)
- Leak indicator kit included and to be fitted with hose opening facing side or down

Related documentation

Mounting instructions : PUM-0016

Repair instructions : PUM-0015

Oil specifications: OIL-0011

Spare parts

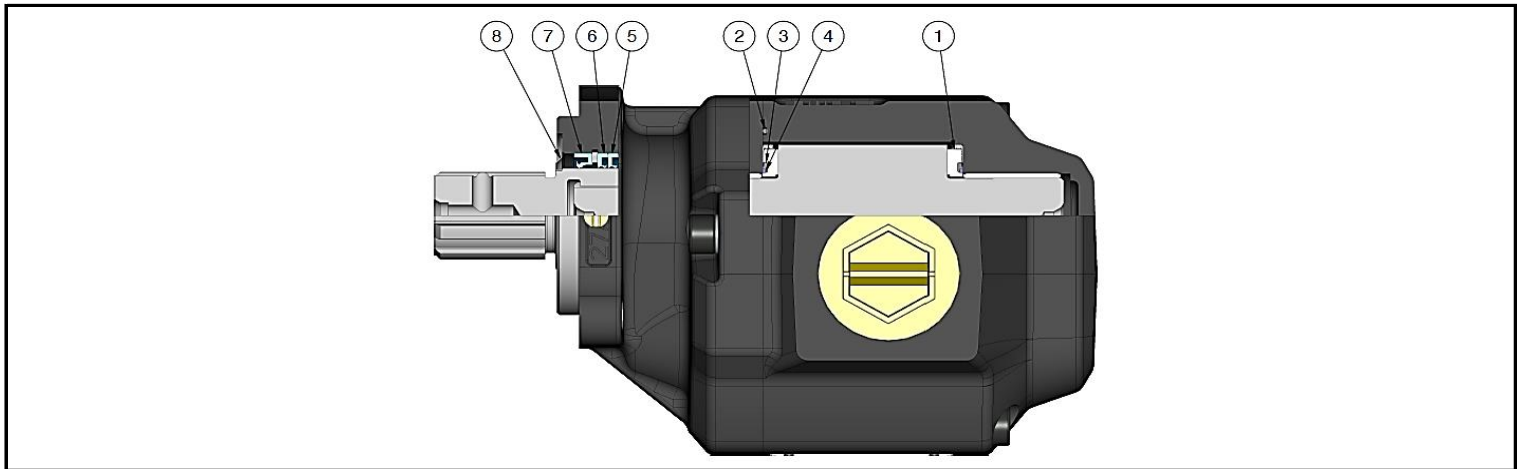

Spare parts

	Type	95cc
	Seal kit (parts : 2, 3, 4, 5, 6, 7 & 8)	02460015
1	Thrust plate	02259408
2	O-ring	see seal kit
3	Seal thrust plate	see seal kit
4	Back-up ring thrust plate	see seal kit
5	Shaft seal	see seal kit
6	Shaft seal	see seal kit
7	Shaft seal	see seal kit
8	Nilos ring	see seal kit
-	Leak indicator kit	02470180

* Leak indicator included with the pump

Hydraulic symbol pump

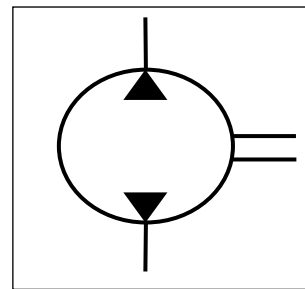

Pressure Definition

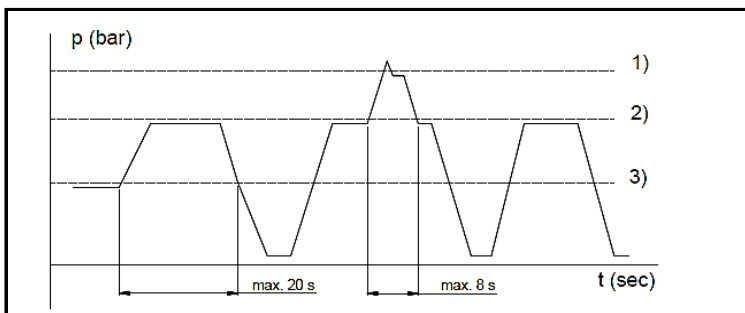

- p 1) Peak pressure
- p 2) Intermittent pressure e.g. tipping applications
- p 3) Continuous Pressure

Torque - Pressure characteristics

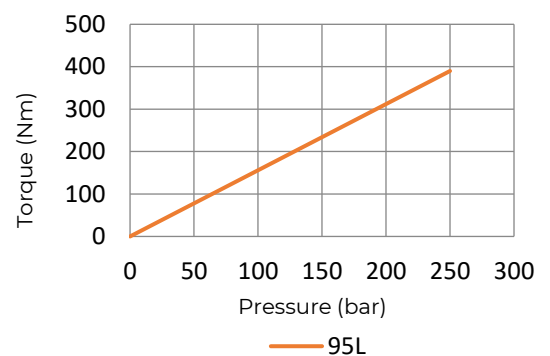

* PTO output torque must be higher than the torque required by the pump

Mounting options

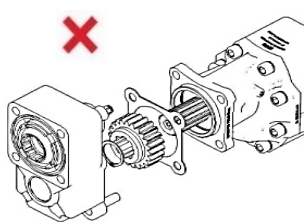

PTO loose gearwheel

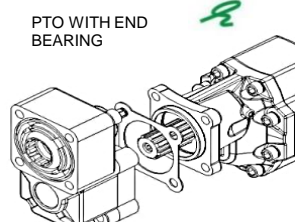

PTO reinforced output

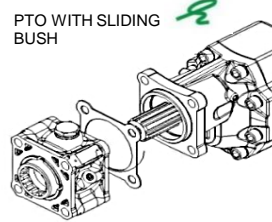

PTO reinforced output

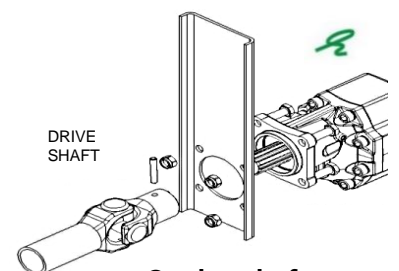

Cardan shaft